



AutomationDirect.com™

Direct Logic 205

Device Net Slave

F2-DEVNETS

TRADEMARKS

™AutomationDirect.com is a Trademark of AutomationDirect.com

™CoProcessor is a Trademark of FACTS Engineering, Inc.

™DeviceNet is a trademark of Open DeviceNet Vendors Association, Inc.

COPYRIGHT

Copyright 1994, FACTS Engineering Inc., 8049 Photonics Dr., New Port Richey, Florida, 34655.. World rights reserved. No part of this publication may be stored in a retrieval system, transmitted, or reproduced in any way, including but not limited to photocopy photograph, magnetic or other recording media, without the prior agreement and written permission of FACTS Engineering, Inc.

Last Issued Date:

Current Issued Date: June 1999

WARNING

Thank you for purchasing automation equipment from FACTS Engineering. We want your new FACTS Engineering automation equipment to operate safely. Anyone who installs or uses this equipment should read this publication (and any other relevant publications) before installing or operating the equipment.

To minimize the risk of potential safety problems, you should follow all applicable local and national codes that regulate the installation and operation of your equipment. These codes vary from area to area and usually change with time. It is your responsibility to determine which codes should be followed, and to verify that the equipment, installation, and operation is in compliance with the latest revision of these codes.

At a minimum, you should follow all applicable sections of the National Fire Code, National Electrical Code, and the codes of the National Electrical Manufacturers Association (NEMA). There may be local regulatory or government offices that can help determine which codes and standards are necessary for safe installation and operation.

Equipment damage or serious injury to personnel can result from the failure to follow all applicable codes and standards. We do not guarantee the products described in this publication are suitable for your particular application, nor do we assume any responsibility for your product design, installation, or operation.

If you have any questions concerning the installation or operation of this equipment, or if you need additional information, please call us at 1-800-783-3225.

This document is based on information available at the time of its publication. While efforts have been made to be accurate, the information contained herein does not purport to cover all details or variations in hardware and software, nor to provide for every possible contingency in connection with installation, operation, and maintenance. Features may be described herein which are not present in all hardware and software systems. FACTS Engineering assumes no obligation of notice to holders of this document with respect to changes subsequently made. FACTS Engineering retains the right to make changes to hardware and software at any time, without notice. FACTS Engineering makes no representation or warranty, expressed, implied, or statutory with respect to, and assumes no responsibility for the accuracy, completeness, sufficiency, or usefulness of the information contained herein. No warranties of merchantability of fitness for purpose shall apply.

TABLE OF CONTENTS

CHAPTER 1: INTRODUCTION	1.1
F2-DEVNETS DESCRIPTION	1.1
REQUIREMENTS	1.1
SPECIFICATIONS	1.1
LED INDICATORS	1.2
NETWORK WIRING	1.2
MODE JUMPER	1.2
CONFIGURATION	1.2
I/O MODULES SUPPORTED	1.3
I/O ADDRESSING	1.4
CHAPTER 2: DEVICENET PROTOCOL	2.1
DEVICENET PLUSES AND MINUSES	2.1
APPLICATIONS	2.1
MODIFIED THINKING	2.1
DEVICENET OVERVIEW	2.1
F2-DEVNETS AND THE PREDEFINED MASTER/SLAVE CONNECTION SET	2.2
DEVICENET I/O POLL COMMAND/RESPONSE MESSAGES	2.2
DEVICENET EXPLICIT REQUEST/RESPONSE MESSAGES	2.2
DEVICENET GROUP 2 ONLY EXPLICIT MESSAGES	2.2
DEVICENET COMMANDS	2.3
CLASS = 1	2.3
CLASS = 3	2.3
CLASS = 4	2.4
CLASS = 5	2.5
HOW TO CONTROL THE F2-DEVNETS MODULE	2.6
1. ESTABLISH CONNECTION(S)	2.6
2. ASSIGN MACID	2.6
3. SET BAUD RATE	2.6
4. SET EPR	2.6
5. GET CONFIGURATION OF MODULES IN THE RACK	2.7
6. GET IDENTITY OF MODULES IN THE RACK	2.8
7. READ ALL INPUT POINTS	2.8
8. SET ALL OUTPUT POINTS	2.9
9. I/O POLL COMMAND	2.9
10. RELEASE CONNECTIONS WHEN DONE	2.9
EXPECTED PACKET RATE(EPR) AND WATCH DOG (WD) TIMEOUTS	2.10
SUMMARY	2.10

CHAPTER 3: INSTALLATION	3.1
STEPS FOR F2-DEVNETS INSTALLATION	3.1
PLANNING THE INSTALLATION	3.1
NETWORK CABLING	3.1
INITIALIZE AND CONNECT EACH F2-DEVNETS	3.2
CONFIGURE AND MAP EACH NODE	3.2
DEVELOP AND TEST THE APPLICATION	3.2
APPENDIX A: CABLING	4.1
TRANSMISSION MEDIA	4.1
Topology	4.1
DeviceNet Media Topology	4.1
Maximum Cable Distance	4.2
Maximum Cable Distance	4.2
Drop Line Budgets	4.3
THICK CABLE	4.3
THIN CABLE	4.4
TERMINATING RESISTORS	4.4
DEVICE TAPS	4.5
Sealed Taps	4.5
Sealed Device Taps	4.5
DeviceNet Sealed Tap with Connectors	4.6
Open Taps	4.7
Open Device Taps	4.7
Open-style Multi-port Tap	4.8
Open-style Tap with One Drop Line and Multiple Device Connectors	4.9

CHAPTER 1: INTRODUCTION

F2-DEVNETS DESCRIPTION

F2-DEVNETS is the FACTS product name of the module for the 205 system designed to operate using the DeviceNet communication protocol. It controls up to 128 I/O points (max of 64 In + 64 Out) as a server(slave) node in a network environment consisting of one Master and up to 63 slave nodes.

DeviceNet offers a method of connecting industrial devices using hardware based on Controller Area Network (CAN) technology and a predefined open protocol.

The information presented in this manual is based on version 2.0 of the Open DeviceNet Vendor Association (ODVA) specification. Readers are encouraged to be familiar with the specification in order to have an appreciation of this product summary and for clarification of concepts.

DeviceNet ability allows communication with other DeviceNet products from other vendors and the flexibility to make processing logic changes from a central location.

REQUIREMENTS

This device requires commands from a DeviceNet Master. The Master can be either a PC or an embedded device, but it must communicate using the Predefined Master/Slave Connection Set as defined in chapter 7 of the DeviceNet Specification manual.

The F2-DEVNETS module is a transfer medium (pipe/wire) thru which data passes and use of this device requires a fundamental overhaul of methods and processes.

All control logic that formerly existed within the PLC, such as RLL, must either reside in the master or be supplied to the master for subsequent communication with F2-DEVNETS. End points connected to the module will supply input data and receive output data as required.

SPECIFICATIONS

Data Rate	Trunk Distance	Drop Length	
125K 250K 500K	500m(1640ft) 250m(820ft) 100m(328ft)	Maximum 6m (20ft) 6m (20ft) 6m (20ft)	Cumulative 156m(512ft) 78m(256ft) 39m(128ft)
Protocol	Predefined master/slave connection set		
LED Status Indication	Power LED - Green Run LED - Green		
Port	5 conductor (signal pair, power pair, drain)		
Maximum I/O	64 Inputs (8 Bytes) / 64 Outputs (8 Bytes)		

LED INDICATORS

The F2-DEVNETS has a PWR LED and a RUN LED. The PWR LED is solid green when power is applied to the base.

The RUN LED illuminates when the CPU and the system becomes operational. The LED will operate accordingly:

SOLID OFF	Performing internal tests; lacking DeviceNet bus power. A flashing LED normally indicates the Module is ready to accept commands. A Difference in the on/off rate helps users Know which of 3 baud rates is in effect.
Flashing	~180 CPM Module expects a 500K baud rate
Flashing	~80 CPM Module expects a 250K baud rate
Flashing	~12 CPM Module expects a 125K baud rate
Flashing	~600 CPM Bus Error
SOLID ON	Module under Master control.

NETWORK WIRING

Pin	Description
1	Shield
2	CAN_L
3	CAN_H
4	Ground (Bus power common)
5	V+ (Bus power positive)

See Appendix A for Cabling information.

MODE JUMPER

Power up the F2-DEVNETS with the MODE jumper shorted on the F2-DEVNETS motherboard to set the MACID and Baud Rate to the factory defaults (MACID=63, Baud Rate=125K). Power down and remove the MODE jumper for normal operation.

CONFIGURATION

The F2-DEVNETS CPU resides in the leftmost slot(CPU slot) of the base with up to 8 I/O modules. All 205 systems include an isolation power supply and are available in three, four, six or nine slot configurations.

Bases which are compatible with an AC external power source also include a built-in 24 VDC 200 ma power supply that can be used to power sensors and the circuits of some I/O modules. Reference the PLC Direct Product Catalog and the DL205 user manual.

<u># I/O modules</u>	<u>Power Source</u>
2,3,5,8	110 or 220 VAC
2,3,5,8	12 VDC or 24 VDC
2,3,5,8	125 VDC

I/O MODULES SUPPORTED

DESCRIPTION	Order Number	Bytes	Module ID
DC Input			
8 pt 24VDC	D2-08ND3	1 In	14H
16 pt 24VDC	D2-16ND3-2	2 In	08H
32 pt 24VDC	D2-32ND3	4 In	05H
AC Input			
8 pt 110 VAC	D2-08NA-1	1 In	14H
16 pt 110 VAC	D2-16NA	2 In	08H
DC Output			
4 pt 12-24 VDC	D2-04TD1	1 Out	0AH
8 pt 12-24 VDC	D2-08TD1	1 Out	13H
16 pt 12-24 VDC	D2-16TD1-1	2 Out	06H
16 pt 12-24 VDC	D2-16TD1-2	2 Out	06H
32 pt 12-24 VDC	D2-32TD1	4 Out	0FH
Specialty Modules			
8 pt Input Simulator	F2-08SIM	1 In	14H
AC Output			
8 pt 18-220 VAC	D2-08TA	1 Out	13H
12 pt 18-220 VAC	D2-12TA	2 Out	11H
Relay Output			
4 pt 4A/pt isolated 8A/MODULE	D2-04TRS	1 Out	0AH
8 pt 1A/pt 4A/MODULE	D2-08TR	1 Out	13H
8 pt 7A/pt isolated	F2-08TRS	1 Out	13H
12 pt 1.5A/pt	D2-12TR	2 Out	06H
Combination Discrete			
4 pt 24 VDC in/ 4pt relay out	D2-08CDR	1 In / 1 Out	0EH
Analog			
2ch out 12 bit current	F2-02DA-1	2 Out	04H
2ch out 12 bit voltage	F2-02DA-2	2 Out	04H
8ch out 12 bit current	F2-08DA-1	2 Out	16H
2ch out 16 bit current	F2-02DAS-1	4 Out	17H
4ch in/2ch out 12 bit current	F2-04AD2DA	2 In / 2 Out	02H
4ch in 12 bit current	F2-04AD-1	2 In	03H
4ch in 12 bit voltage	F2-04AD-2	2 In	03H
4ch in 16 bit RTD	F2-04RTD	3 In	15H
4ch in 16 bit voltage/THM	F2-04THM	3 In	15H
8ch in 12 bit current	F2-08AD-1	2 In	01H
8ch in 12 bit voltage	F2-08AD-2	2 In	01H

I/O ADDRESSING

The F2-DEVNETS CPU uses one node address for all points. The MACID which is assigned by the Master device defaults to 63 when the unit powers up for the first time. The master will be responsible for coordinating the correct ID assignments to each of the slaves.

Within each node(EACH F2-DEVNETS) the I/O points are known by their order in the rack. This information is also readily available to the Master whenever certain predefined configuration commands are sent. This information includes the number of installed I/O modules, the slots that are filled, the type of modules installed and the numbers of I/O points.

The Master will pass this information on to the application program and the user interface program.

CHAPTER 2: DEVICENET PROTOCOL

DEVICENET PLUSES AND MINUSES

- ✓ Low cost twisted pair for signal and power
 - ✓ Simultaneous support for network-powered and self-powered devices.
 - ✓ Trunk line-dropline configuration
 - ✓ Node removal without severing the network
 - ✓ Selectable data rates of 125k, 250k or 500k baud rates
 - ✓ Lowcost network hardware originally designed for automobile systems are rugged and dependable.
 - ✓ Advanced error management with bus monitoring diagnostics
- ⊗ An increase in the complexity of the system is expected when a network is used to control devices. Resources providing for the care and feeding of another layer or more of automation control must be considered. An external CPU performing the function of a Master CPU will control the action of the F2-DEVNETS module by requesting input data from the end points(production) and sending the required output to the end points(consumption). All processing logic related to the specific application resides in the Master.

APPLICATIONS

A DeviceNet network is typically used to connect low-level intelligent devices such as bar-code scanners, motor controllers, sensors and general purpose PLC's like the F2-DEVNETS. This provides a single point of control using a master controller and allows for more efficient processing coordination.

MODIFIED THINKING

DeviceNet concepts center around the abstraction known as object modeling. Terms like connections, instances and attributes force a redefinition of vocabularies and thinking.

F2-DEVNETS is the interface between a high-level MASTER CONTROLLER and controlling devices such as sensors and relays. Quite simply it provides the communication medium(pipe) thru which data can flow. This data can be a product name, input sensor values and the controlling signals that operate output devices.

DEVICENET OVERVIEW

DeviceNet uses the Controller Area Network (CAN) technology as the physical medium for the network. DEVICENET is a broadcast oriented protocol whose data frames are assigned an identifier value known as the Connection Id (CID). Each node decides to accept a particular frame by looking at the CID during the early part of the transfer. Likewise, a node's transmission is heard by all other nodes on the network. Any transmission on the wire must be completed before another node can send data.

F2-DEVNETS AND THE PREDEFINED MASTER/SLAVE CONNECTION SET

The F2-DEVNETS uses the predefined Master/Slave connection set. This predefined subset of the full implementation means there will be some limitations. The F2-DEVNETS module does not have the resources needed to support the management of dynamic explicit messaging and I/O connections of the Unconnected Message Manager(UCMM).

The most significant aspect will be that the F2-DEVNETS requires a master device to 'be in charge' of communications. The master will establish up to two connections to the F2-DEVNETS module and will own or have sole control over all I/O until those connections are released. There will be no peer-to-peer level communications.

The master typically will be a PC computer that will be sending control data to the 205 which will respond by returning readings from its input sensors. The 205 will respond to commands from only one master at any point in time. Another master may establish control after the current connection has been deallocated(released).

DEVICENET I/O POLL COMMAND/RESPONSE MESSAGES

The Poll Command is transmitted by the master and is directed toward a single, specific end node. This is used for data transfer between the master and the F2-DEVNETS. The master transmits a single Poll message for each of its slaves and the slave responds to this specific command over a single connection object. There is always data sent by the master to be consumed by the F2-DEVNETS module and data will be returned(produced) by the F2-DEVNETS module.

F2-DEVNETS automatically configures the poll data for the proper number of I/O points with a maximum of eight input bytes(64 points) and eight output bytes(64 points). Larger amounts of data such as that required by the product name and other data groups as specified in the Assembly group use the Explicit method of data transfer.

DEVICENET EXPLICIT REQUEST/RESPONSE MESSAGES

These commands perform reading/writing of attributes such as serial numbers, Vendor Id's and product names. They are sent/received by a single connection object. This method can handle more than 8 bytes of data because it can send/receive fragmented messages.

DEVICENET GROUP 2 ONLY EXPLICIT MESSAGES

These are used to allocate/release the connection between the master and its slave.

DEVICENET COMMANDS

The following list identifies the data being transferred. **GET** by itself under the services column means the item is fixed and cannot change or that the system sets the item to reflect the system processing characteristics. **SET** indicates the user can modify the item.

Unless otherwise indicated all data is given in HEX format. Single numbers shall be considered zero filled and right justified.

CLASS = 1

ATTR	INSTANCE	ITEM	VALUE	DESCRIPTION	SERVICE
1	1	VENDOR ID	157d	Unique Code Assigned by ODVA	GET
2	2	PRODUCT TYPE	0	General Purpose I/O Device	GET
3	1	PRODUCT CODE	20	Vendor Assigned Product Code	GET
4	1	REVISION MAJOR.MINOR	2.5	Released Product Version	GET
5	1	ID STATUS	1	Current Status of Entire Device	GET
6	1	SERIAL NUMBER	XXXX	4-Digit Vendor Assigned	GET
7	1	PRODUCT NAME	F2-DEVNETS	Vendor Assigned	GET
--	1	RESET		Reset the Device	RESET

CLASS = 3

ATTR	INSTANCE	ITEM	VALUE	DESCRIPTION	SERVICE
1	1	MACID	0-63	MACID(media access control id)	GET/SET
2	1	BAUD RATE	0-2	0=125k,1=250k,2=500k baud	GET/SET
3	1	BUS OFF INTERRUPT	X	BUS-OFF INTERRUPT PROCESSING	GET
4	1	BUS OFF COUNT	X	BUS-OFF COUNT	GET/SET
5	1	ALLOCATION	X	EXPLICIT AND I/O CONNECTIONS	GET

CLASS = 4

ATT R	INSTANCE	ITEM	VALUE	DESCRIPTION	SERVICE
3	1	I/O DATA	8 Bytes	Read Input Data (Produced) Write Output Data (Consumed)	GET / SET
3	2	CONFIG DATA	4 Bytes + 1 Word (16 Bits) for each occupied slot. Bytes 1-4 are always supplied. Other bytes are supplied when appropriate.		GET
		BYTE 1	0-3F (63d)	MAC ID	
		BYTE 2	0-2	BAUD RATE	
		BYTE 3	0-8	SLOTS (0=Empty Rack)	
		BYTE 4	0-FF	SLOTS FILLED (Bit 0=Slot 0, Bit 1=Slot 1, etc.)	
		BYTES 5/6	Bits 15-13 Bits 12-8 Bits 7-0	Slot Position Relative to 0 # Inputs # Outputs	
3	3	CONFIG DATA	8 Bytes	Configuration Data with the module ID for each occupied slot. 0FFH=Unoccupied	GET
		Byte 1		ID of Module in Slot 0	
		Byte 2		ID of Module in Slot 1	
		Byte 3		ID of Module in Slot 2	
		Byte 4		ID of Module in Slot 3	
		Byte 5		ID of Module in Slot 4	
		Byte 6		ID of Module in Slot 5	
		Byte 7		ID of Module in Slot 6	
		Byte 8		ID of Module in Slot 7	
3	4	PRODUCED DATA	0-0FFFFH	4 Channels (8 Bytes) of Analog Inputs (1st 4 of last 8 Analog Inputs in Base)	GET
3	5	PRODUCED DATA	0-0FFFFH	4 Channels (8 Bytes) of Analog Inputs (2nd 4 of last 8 Analog Inputs in Base)	GET
3	6	PRODUCED DATA	0-0FFFFH	4 Channels (8 Bytes) of RTD/THM Inputs	GET

CLASS = 5

ATTR	INSTANCE 1=EXPLICIT 2=POLLING	ITEM	VALUE	DESCRIPTION	SERVICE
1	1/2	CNXN ATTR STATE	X	0=None, 1=Configuring, 2=Waiting, 3=Connected, 4=Timed-Out	GET
2	1/2	CONNECT TYPE	X	0=Explicit 1=I/O	GET
3	1/2	CONNECT TRIGGER	X	083H Explicit 082H I/O	GET
4	1/2	CONNECT PRODUCED	X	Connection ID that will produce...FFFF if no production	GET
5	1/2	CONNECT CONSUMED	X	Connection ID that will consume...FFFF if no consumption	GET
6	1/2	CONNECT COMM ID	021h	MSG Group2 Consuming MSG Group1 Producing	GET
7	1/2	PRODUCED CONNECTION SIZE	X	8 Bytes of Non-Fragmented I/O Data Up to 10 Bytes Fragmented Explicit Messaging	GET
8	1/2	CONSUMED CONNECTION SIZE	X	8 Bytes of Non-Fragmented I/O Data Up to 10 Bytes Fragmented Explicit Messaging	GET
9	1/2	CONNECT EXPECTED PACKET RATE	X	Number of Milliseconds	GET/SET
0C	1/2	CONNECT WD TIMEOUT	0	Watch-Dog Time-Out Action Reset Device	GET
0D	1/2	CONNECT PATH LENGTH	X	0 for Explicit 6 for I/O	GET
0E	1/2	CONNECT PATH ATTR ID	0/STRING	0 for Explicit 6 Bytes for I/O	GET
0F	1/2	CONNECT CONSUMED PATH LENGTH	X	0 for Explicit 6 for I/O	GET
10	1/2	CONNECT CONSUMED ATTR ID	0/STRING	0 for Explicit 6 Bytes for I/O	GET
11	1/2	PROD INHIBIT	X		GET
--	1/2	RESET	--	Start Inactivity Timer	RESET

HOW TO CONTROL THE F2-DEVNETS MODULE

Many commands are available within DeviceNet to control the 205 system, but not all are required to successfully operate the unit. Some Commands are described below using DeviceNet terms and are shown with the first bytes sent in the leftmost position.

Section 5. Details the sample situation of a 6-slot 205 rack populated with a variety of modules. The commands listed represent only some of the commands needed to control the 205's I/O points.

Expected data for the application is shown. If no data is expected then the response field is omitted. The protocol does require a response from the 205 for each command sent, but for simplicity the empty responses are not shown.

1. ESTABLISH CONNECTION(S)

Msgid	Service	Class	Instance	Attribute	Macid
6	4B	3	1	3	3F

2. ASSIGN MACID

Msgid	Service	Class	Instance	Attribute	Macid
4	10	3	1	1	3F

3. SET BAUD RATE

Msgid	Service	Class	Instance	Attribute	Macid
4	10	3	1	2	3F
Data Byte 0					
2	500K baud				
1	250K baud				
0	125K baud				

4. SET EPR

Msgid	Service	Class	Instance	Attribute	Macid
4	10	5	1	9	3F
Data Byte 0 and 1					
0	0	No EPR action			
10	0	10 millisecond action			

5. GET CONFIGURATION OF MODULES IN THE RACK

Msgid	Service	Class	Instance	Attribute	Macid
4	E	4	2	3	3F
Reply data Note: The amount of data in the reply is dependent on the number of occupied slots in the rack. Our example has five I/O slots of a 6 slot rack occupied with a variety of modules. Spaces are injected to separate the data while the 16 data(2-bytes) are joined. Refer to the DeviceNet Command section for a description of the bytes. Slots for all I/O modules start at zero for the first slot to the right of the CPU and are sequentially numbered. The CPU always occupies the leftmost slot in the rack.					
Data Byte 0					
3F	MACID				
Data Byte 1					
02	BAUD RATE				
Data Byte 2					
05	NUMBER OF FILLED I/O SLOTS				
Data Byte 3					
1F	OCCUPIED SLOTS				
Data Byte 4 and 5					
00	08	SLOT 0; 0 IN; 8 OUT			
Data Byte 6 and 7					
10	00	SLOT 1; 16 IN; 0 OUT			
Data Byte 8 and 9					
08	00	SLOT 2; 8 IN; 0 OUT			
Data Byte 10 and 11					
18	00	SLOT 3; 24 IN; 0 OUT			
Data Byte 12 and 13					
00	10	SLOT 4; 0 IN; 16 OUT			

6. GET IDENTITY OF MODULES IN THE RACK

Msgid	Service	Class	Instance	Attribute	Macid
4	E	4	3	3	3F
Reply data Note: 8 bytes are always returned 0FFH indicates an unoccupied slot The bytes are shown with slot 0 in the left-most position with the remaining slot values in consecutive order.					
Data Byte 0					
13	F2-08TR				
Data Byte 1					
03	F2-04AD-2				
Data Byte 2					
14	D2-08ND3(SIMULATOR)				
Data Byte 3					
15	F2-04RTD				
Data Byte 4					
04	F2-02DA-2				
Data Byte 5					
FF	not occupied				
Data Byte 6					
FF	not occupied				
Data Byte 7					
FF	not occupied				

7. READ ALL INPUT POINTS

Msgid	Service	Class	Instance	Attribute	Macid
4	E	4	1	3	3F
Data Bytes Note: The module will return the exact number of bytes of data as supplied by the input modules in the rack. The data coming may be fragmented if there are more than 5 bytes.					

8. SET ALL OUTPUT POINTS

Msgid	Service	Class	Instance	Attribute	Macid
4	10	4	1	3	3F

Data Bytes
Note: If 8 bytes are sent some bytes may be of the 'do not care' variety when that slot is empty or is an input module. The data will be fragmented

9. I/O POLL COMMAND

The I/O poll command is a non-fragmented poll command and response mechanism that exists on a separate connection. The group 2 message originates with the master while the group 1 message response comes from the server. The response (production or input) from the slave(server) is always given in reply to the data sent to the slave(output or consumption).

This is exactly the same information transferred using 6 & 7 above, but this is more efficient because of less message overhead due to no fragmentation.

10. RELEASE CONNECTIONS WHEN DONE

Msgid	Service	Class	Instance	Allocation
6	4C	3	1	3

EXPECTED PACKET RATE(EPR) AND WATCH DOG (WD) TIMEOUTS

The F2-DEVNETS has an internal timer that can be set to timeout after a selectable number of milliseconds. If there is no activity during the selected time value the connection will release. **When this timer is set to zero the connection will not timeout.**

Since our operation depends on the controlling actions of a Master CPU existing externally on the net there is no compelling reason to allow the connection to timeout. So to keep the connections(s) open simply set the EPR value for each of the connections to zero.

All outputs will turn off when the connection is released. This will occur when an PER value counts down to zero or when the connection is released by the master. This is a fixed condition and cannot be modified.

SUMMARY

F2-DEVNETS is a slave(server) on the network. Nothing will happen unless a master control sends the proper commands to the unit. Many commands exist, but only a few are required to get the unit producing/consuming.

A prescribed series of events is followed to enable communications between the two modules. When a path is established the master can read/write as required.

Initially, the MACID of the F2-DEVNETS module will be 63, a default value. The Master of the network should plan to access this unit with this default MACID the first time the unit powers up with the network. Afterward the Master can assign another MACID value which will be retained by the unit.

The default baud rate of the connection will be 125k baud. This can be changed by the Master and the value will be retained by the unit during subsequent power cycles.

The system uses two connections to transfer information. The **explicit** connection is used for command processing and the **poll** connection is used to handle I/O.

Explicit commands listed in **DeviceNet Commands** are used to access specific items directly related to supporting the transfer of I/O data to and from the end point modules. Things like baud rate, serial numbers and product names will be sampled and updated as necessary.

The I/O needed by the master for input can be obtained either by a single assembly data command or by the poll command on a regular basis. In a like manner the I/O needed by the master for output can be sent either by a single assembly data command or by the poll command on a regular basis. The term assembly is a grouping term used when describing related items.

Each connection can be maintained separately or they can be allocated/released together.

CHAPTER 3: INSTALLATION

STEPS FOR F2-DEVNETS INSTALLATION

1. Plan the installation.
2. Run cable for each node and wire connectors.
3. Use your DeviceNet master or configuration software to set the Baud Rate and assign a unique MAC ID for each F2-DEVNETS.
4. Connect 24VDC network power to each F2-DEVNETS node and connect it to the network cabling.
5. Use your DeviceNet master to configure and map each F2-DEVNETS node.
6. Develop and test your application.

PLANNING THE INSTALLATION

The F2-DEVNETS slave is only one component of a DeviceNet network. Look at the requirements of your system and the capabilities of each component to make sure that your needs are met.

The DeviceNet master and Application software will have the most effect on the capabilities of the system. There are many possible DeviceNet masters including Think N Do software from **Automationdirect.com**. Research the master you are planning to use to make sure it meets the needs of your application.

The DeviceNet protocol uses a Trunk and Drop cable configuration or a Daisy Chain (zero length drop) cable configuration. Refer to the 'SPECIFICATIONS' table in chapter 1 to make sure your installation will be within the maximum distance limits. The distance of your trunk and drops also determines the maximum baud rate you can use.

The DeviceNet protocol allows for MACID addresses in the range of 0-63. One of these addresses will be the DeviceNet master and another may be needed for the DeviceNet configuration tool. Make sure there are enough addresses for your application.

Each F2-DEVNETS CPU supports up to 8 Bytes of Inputs and 8 Bytes of Outputs. Make sure the I/O configuration for each F2-DEVNETS node is within these limits. Refer to the 'I/O MODULES SUPPORTED' table in chapter 1.

In the F2-DEVNETS Analog Inputs must be demultiplexed and Analog Outputs must be multiplexed. Make sure your chosen master is able to do these functions if you are using analog I/O. Refer to the 'DL 205 Analog I/O Modules' manual for bit definitions of analog modules. The Think N Do software handles these functions automatically.

NETWORK CABLING

See Appendix A for cabling details.

INITIALIZE AND CONNECT EACH F2-DEVNETS

Each F2-DEVNETS CPU is shipped from the factory with a default MACID address of 63 and a baud rate of 125K. You will need to assign a unique address address to each F2-DEVNETS and set the baud rate.

Each DeviceNet master or DeviceNet configuration software is different so you will need to refer to the documentation of the particular master or configuration software that you are using for instructions on how to make these changes.

After intializing each F2-DEVNETS connect 24VDC (Bus Power) and connect each one to the network. Use your DeviceNet master or configuration tool to verify each node is found.

CONFIGURE AND MAP EACH NODE

The next step is map the I/O for each F2-DEVNETS node into the DeviceNet master. Typically this is where you will need to specifiy the number of bytes of inputs and outputs in each node in order for the master to be able to successfully poll each node.

Each DeviceNet master or DeviceNet configuration software is different so you will need to refer to the documentation of the particular master or configuration software that you are using for instructions on how to configure and map each node.

DEVELOP AND TEST THE APPLICATION

Each DeviceNet master or DeviceNet configuration software is different so you will need to refer to the documentation of the particular master or configuration software that you are using for details on developing the application.

APPENDIX A: CABLING

NOTE: The information contained in this appendix is taken from the Open DeviceNet Vendor Association, Inc. DeviceNet Specification Volume I Chapter 9 Section 3.

TRANSMISSION MEDIA

The following sections describe the characteristics of the Transmission Media for DeviceNet. The DeviceNet trunk line - drop line topology can be constructed of either DeviceNet Thick Cable or DeviceNet Thin Cable, or a combination of both. Thick Cable allows long trunk line distances and more sturdy trunk lines or drop lines. Thin Cable provides easier routing and termination of either trunk lines or drop lines.

Topology

The DeviceNet media has a linear bus topology. Terminating resistors are required on each end of the

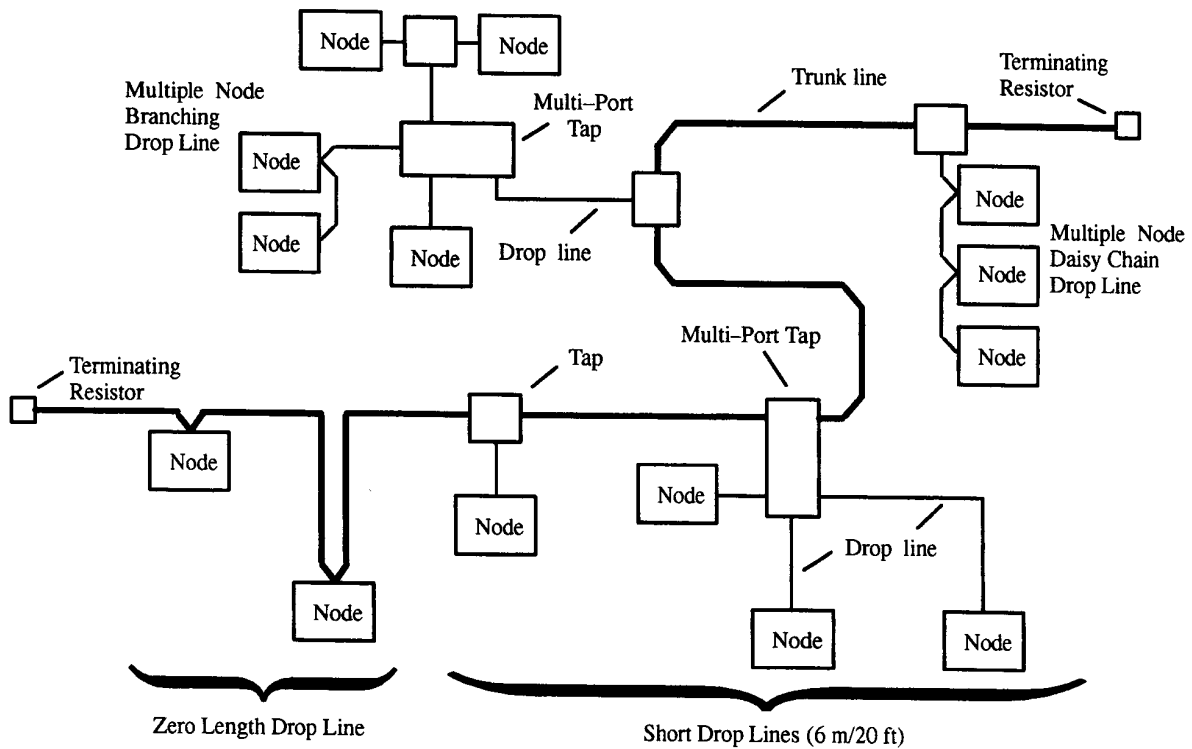

trunk line. Drop lines as long as 6 m (20 feet) each are permitted, allowing one or more nodes to be attached. DeviceNet allows branching structures only on the drop line.

DeviceNet Media Topology

NOTE: The information contained in this appendix is taken from the Open DeviceNet Vendor Association, Inc. DeviceNet Specification Volume I Chapter 9 Section 3.

The total amount of trunk line allowable on the network depends upon the data rate and the type of cable (thick or thin) used. The cable distance between any two points in the cable system must not exceed the Maximum Cable Distance allowed for the baud rate. For trunk lines constructed of only one type of cable, use the following table to determine the Maximum Cable Distance based on the data rate and the type of cable used. Cable distance between two points includes both trunk line cable length and drop line cable length that exists between the two points.

Maximum Cable Distance

Data Rate	Maximum Cable Distance for 100 % Thick Cable	Maximum Cable Distance for 100 % Thin Cable
125k baud	500 meters (1640 ft.)	100 meters (328 ft.)
250k baud	250 meters (820 ft.)	
500k baud	100 meters (328 ft.)	

DeviceNet allows the use of either thick or thin cable to be used to construct trunk lines. DeviceNet also allows a combination of both types of cable to be used on the same network. To determine the

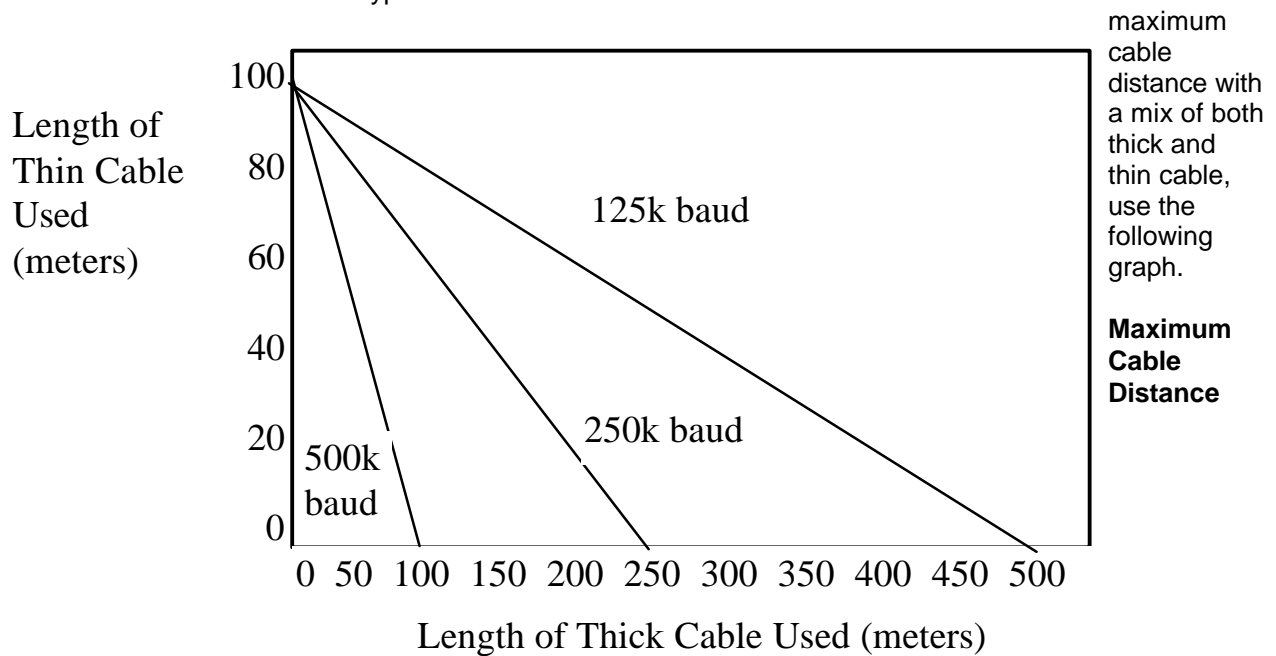

$$L_{\text{thick}} + 5 \times L_{\text{thin}} = 500 \quad \text{at 125Kbaud}$$

$$L_{\text{thick}} + 2.5 \times L_{\text{thin}} = 250 \quad \text{at 250Kbaud}$$

$$L_{\text{thick}} + L_{\text{thin}} = 100 \quad \text{at 500Kbaud}$$

where L_{thick} is the length of thick cable and L_{thin} is the length of thin cable.

NOTE: The information contained in this appendix is taken from the Open DeviceNet Vendor Association, Inc. DeviceNet Specification Volume I Chapter 9 Section 3.

Drop line length is the longest cable distance of those measured from the tap on the trunk line to each of the transceivers of the nodes on the drop line. The total amount of drop line allowable on the network depends upon the data rate. Refer to the following drop line budget when determining the number and length of drop lines.

Drop Line Budgets

Data Rate	Drop Length	
	Maximum	Cumulative
125k baud	6 Meters (20ft)	156 Meters (512 ft)
250k baud		78 Meters (256 ft.)
500k baud		39 Meters (128 ft)

THICK CABLE

This cable consists of two shielded pairs twisted on a common axis with a drain wire in the center covered with an overall braid shield and is commonly used as trunk line when length is important.

Listed below are general requirements for the DeviceNet Thick Cable. Other types of external insulation and/or jacketing are allowable provided that internal construction and electrical characteristics adhere to the cable specifications.

- One twisted signal pair (#18); blue/white
- One twisted power pair (#15); black/red
- Separate aluminized mylar shields around power pair and signal pair
- Overall foil/braid shield with drain wire (#18); bare*
- High speed ($V_p = 75\%$ min), low loss, low distortion, data pair (to keep propagation delays to a minimum)
- 8 amp maximum current capacity
- PVC insulation on power pair
- Industrial temperature range
- High flexibility

*The drain wire connects the shields within the cable and serves as a means to terminate the shield into the connector.

NOTE: The information contained in this appendix is taken from the Open DeviceNet Vendor Association, Inc. DeviceNet Specification Volume I Chapter 9 Section 3.

THIN CABLE

Thin Cable is smaller and more flexible than Thick Cable. It is commonly used for drop lines, but can also be used, for shorter distances, as trunk line.

Listed below are general requirements for the DeviceNet Thin Cable. Other types of external insulation and/or jacketing are allowable provided that internal construction and electrical characteristics adhere to the cable specifications. See Appendix B, DeviceNet Cable Specifications for details.

- One twisted signal pair (#24); blue/white
- One twisted power pair (#22); black/red
- Separate aluminized mylar shields around power pair and signal pair
- Overall foil/braid shield with drain wire (#22); bare*
- High speed ($V_p = 75\%$ min.), low loss, low distortion, data pair (to keep propagation delays to a minimum)
- 3 amp maximum current capacity
- PVC insulation on power pair
- Industrial temperature range
- High flexibility

*The drain wire connects the shields within the cable and serves as a means to terminate the shield into the connector.

TERMINATING RESISTORS

DeviceNet requires a terminating resistor to be installed at each end of the trunk. The resistor requirements are:

- 121 ohm
- 1 % Metal Film
- 1/4 Watt

Important: Terminating resistors should never be included in nodes. Inclusion of this capability could easily lead to a network with improper termination (too high or too low an impedance) potentially causing failure. For example, removal of a node which includes a terminating resistor could result in network failure.

Important: Terminating resistors should not be installed at the end of a drop line, only at the two ends of the trunk line.

NOTE: The information contained in this appendix is taken from the Open DeviceNet Vendor Association, Inc. DeviceNet Specification Volume I Chapter 9 Section 3.

DEVICE TAPS

Device taps provide points of attachment onto the trunk line. Devices can be connected to the network either directly to the tap or with a drop line. Taps also provide easy removal of a device without disrupting network operation.

Taps are defined for:

- sealed (with and without drop lines)
- open (with and without drop lines)

Sealed Taps

Three examples of sealed device taps allowed on DeviceNet.

Sealed Device Taps

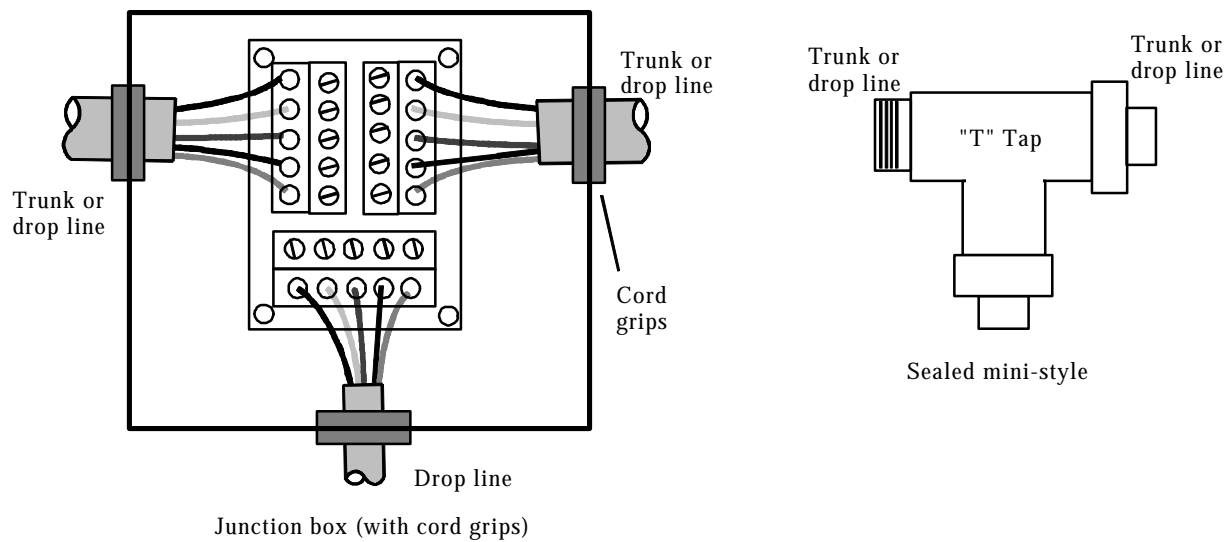

Junction box (with cord grips)

Sealed mini-style

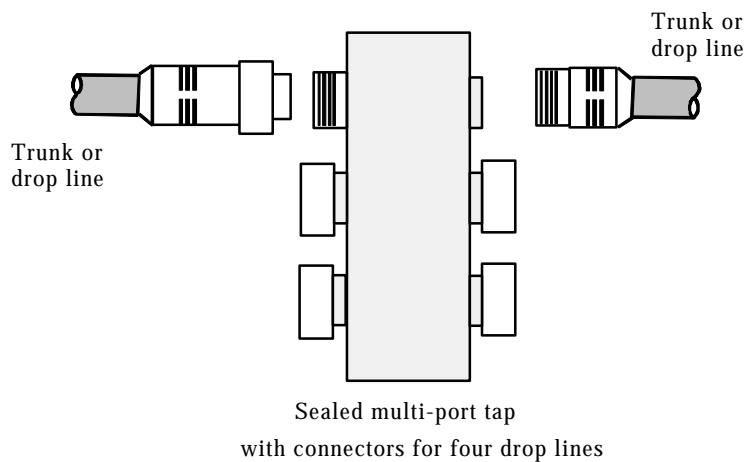

Sealed multi-port tap
with connectors for four drop lines

NOTE: The information contained in this appendix is taken from the Open DeviceNet Vendor Association, Inc. DeviceNet Specification Volume I Chapter 9 Section 3.

The following figure illustrates a DeviceNet sealed tap with connectors. DeviceNet requires that molded sealed taps have the following specifications if using mini-style connectors:

- Connectors with pins (male) have external threads (rotation optional)
- Connectors with sockets (female) have internal threads (rotation required)

If micro-style connectors are used, then the connectors with pins (male) have rotation required, and the connectors with sockets (female) have rotation optional.

DeviceNet Sealed Tap with Connectors

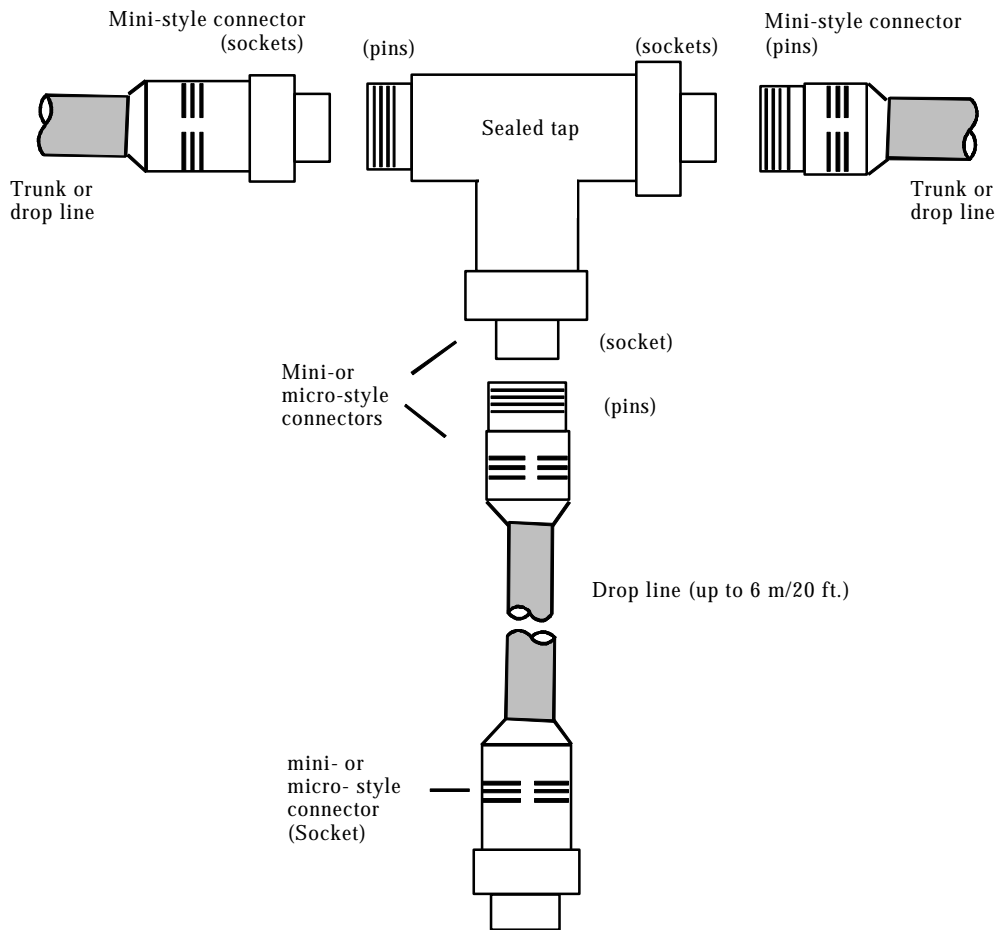

NOTE: The information contained in this appendix is taken from the Open DeviceNet Vendor Association, Inc. DeviceNet Specification Volume I Chapter 9 Section 3.

Open Taps

The following figure shows two types of open taps for DeviceNet. The open, zero drop length tap provides two sets of wire terminations to allow daisy chaining of the trunk line.

The open tap with a drop consists of three sets of terminals to allow a drop line of up to 6 m/20 ft. to be connected to the trunk. This style of tap will typically be used inside a control cabinet to connect a device to the trunk line.

Open Device Taps

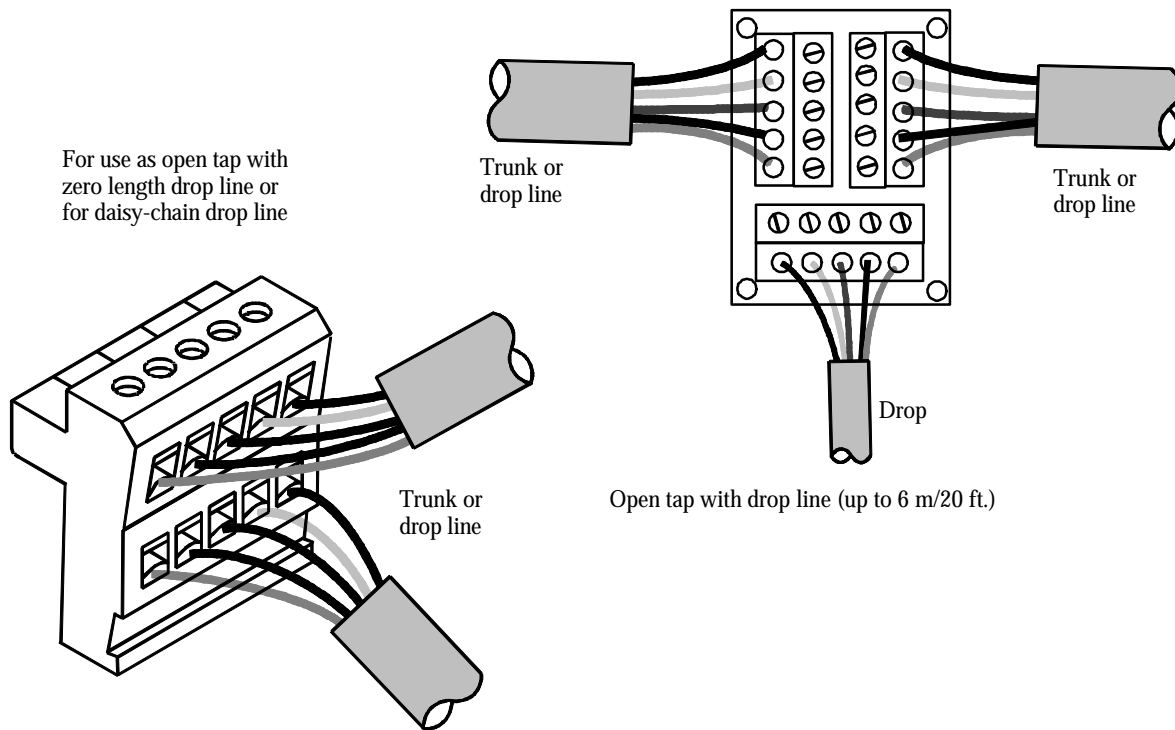

NOTE: The information contained in this appendix is taken from the Open DeviceNet Vendor Association, Inc. DeviceNet Specification Volume I Chapter 9 Section 3.

When multiple devices are located within the same control cabinet, one of the following approaches for attaching devices to the network may be used:

- use a multi-port tap (individual drop lines for each device).
- use an open-style tap with one drop line and multiple connectors.

Open-style Multi-port Tap

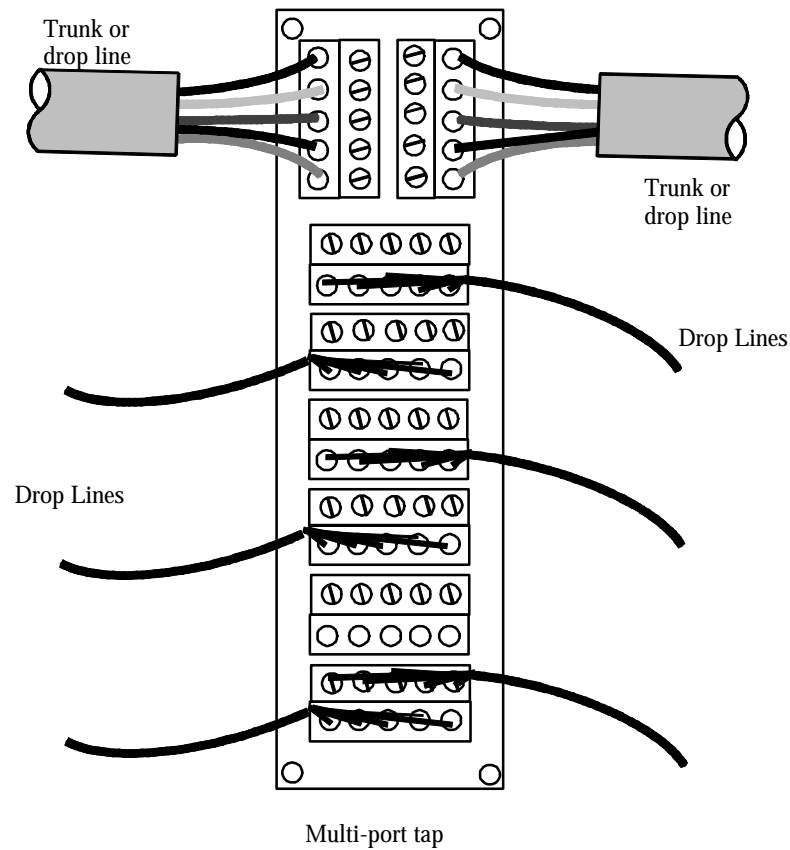

NOTE: The information contained in this appendix is taken from the Open DeviceNet Vendor Association, Inc. DeviceNet Specification Volume I Chapter 9 Section 3.

Open-style Tap with One Drop Line and Multiple Device Connectors

